

## DECLARATION OF PERFORMANCE

### DoP 0184

for fischer concrete screw ULTRACUT FBS II (Mechanical fastener for use in concrete)

EN

1. <u>Unique identification code of the product-type:</u>	<b>DoP 0184</b>		
2. <u>Intended use/es:</u>	<b>Post-installed fastening in cracked or uncracked concrete.</b>		
3. <u>Manufacturer:</u>	<b>See appendix, especially annexes B1- B5 fischerwerke GmbH &amp; Co. KG, Klaus-Fischer-Str. 1, 72178 Waldachtal, Germany</b>		
4. <u>Authorised representative:</u>	–		
5. <u>System/s of AVCP:</u>	1		
6. <u>European Assessment Document:</u> European Technical Assessment: Technical Assessment Body: Notified body/ies:	<b>EAD 330232-01-0601, (Edition 12/ 2019) ETA-15/0352; 2020-04-14 DIBt- Deutsches Institut für Bautechnik 1343 MPA Darmstadt / 2873 TU Darmstadt</b>		
7. <u>Declared performance/s:</u> <b>Mechanical resistance and stability (BWR 1)</b> Characteristic resistance to tension load (static and quasi-static loading):	Resistance to steel failure: Resistance to pull- out failure:  Resistance to concrete cone failure: Robustness:  Minimum edge distance and spacing: Edge distance to prevent splitting under load:	Annexes C1, C2 Annexes C1, C2  Annexes C1, C2 Annexes C1, C2  Annex B4 Annex C1, C2	$E_s = 210\,000\text{ MPa}$
Characteristic resistance to shear load (static and quasi-static loading), Method A:	Resistance to steel failure (shear load): Resistance to pry-out failure:	Annexes C1, C2 Annexes C1, C2	
Characteristic resistance and displacements for seismic performance categories C1 and C2:	Resistance to tension load, displacements, category C1: Resistance to tension load, displacements, category C2: Resistance to shear load, displacements, category C1: Resistance to shear load, displacements, category C2: Factor for annular gap:	Annex C3 Annexes C4, C7 Annex C3 Annexes C4, C7 Annex C4	$V_{Rk,p,C1} = \text{NPD}$ $V_{Rk,p,C2} = \text{NPD}$
Characteristic Resistance for simplified design:	Method B: Method C:	NPD NPD	
Displacements and durability:	Displacements under static and quasi-static loading: Durability:	Annex C7 Annexes A4, B1	
<b>Safety in case of fire (BWR 2)</b> Reaction to fire: Resistance to fire:	Class (A1) Fire resistance to steel failure (tension load): Fire resistance to pull-out failure (tension load): Fire resistance to steel failure (shear load):	Annexes C5, C6 Annexes C5, C6 Annexes C5, C6	



8. Appropriate Technical Documentation and/or  
Specific Technical Documentation:

The performance of the product identified above is in conformity with the set of declared performance/s. This declaration of performance is issued, in accordance with Regulation (EU) No 305/2011, under the sole responsibility of the manufacturer identified above.

Signed for and on behalf of the manufacturer by:

Thilo Pregartner, Dr.-Ing.  
Tumlingen, 2020-04-28

Peter Schillinger, Dipl.-Ing.

This DoP has been prepared in different languages. In case there is a dispute on the interpretation the English version shall always prevail.

The Appendix includes voluntary and complementary information in English language exceeding the (language-neutrally specified) legal requirements.

## Specific Part

### 1 Technical description of the product

The fischer concrete screw ULTRACUT FBS II is an anchor of sizes 6, 8, 10, 12 and 14 mm made of hardened carbon steel. The anchor is screwed into a predrilled cylindrical drill hole. The special thread of the anchor cuts an internal thread into the member while setting. The anchorage is characterised by mechanical interlock in the special thread.

The product description is given in Annex A.

### 2 Specification of the intended use in accordance with the applicable European Assessment Document

The performances given in Section 3 are only valid if the anchor is used in compliance with the specifications and conditions given in Annex B.

The verifications and assessment methods on which this European Technical Assessment is based lead to the assumption of a working life of the anchor of at least 50 years. The indications given on the working life cannot be interpreted as a guarantee given by the producer, but are to be regarded only as a means for choosing the right products in relation to the expected economically reasonable working life of the works.

### 3 Performance of the product and references to the methods used for its assessment

#### 3.1 Mechanical resistance and stability (BWR 1)

Essential characteristic	Performance
Characteristic resistance to tension load (static and quasi-static loading)	See Annex B4, Annex C 1 and C 2
Characteristic resistance to shear load (static and quasi-static loading)	See Annex C 1 and C 2
Displacements and Durability	See Annex C 7 and Annex B 1
Characteristic resistance and displacements for seismic performance categories C1 and C2	See Annex C 3, C 4 and C 7

#### 3.2 Safety in case of fire (BWR 2)

Essential characteristic	Performance
Reaction to fire	Class A1
Resistance to fire	See Annex C 5 and C 6

**4 Assessment and verification of constancy of performance (AVCP) system applied, with reference to its legal base**

In accordance with European Assessment Document EAD No. 330232-01-0601 the applicable European legal act is: [96/582/EC].

The system to be applied is: 1

**Product in the installed condition**

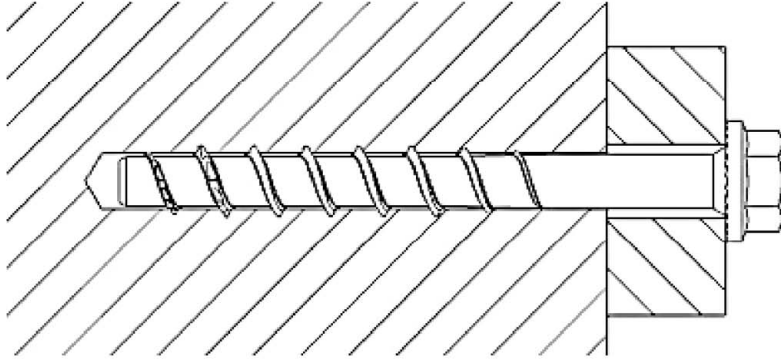

FBS II US

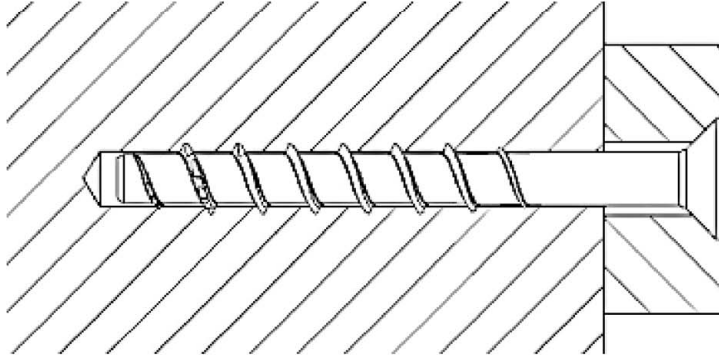

FBS II SK

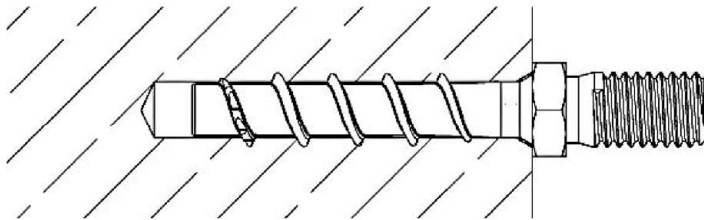

FBS II 6 M8









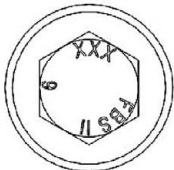
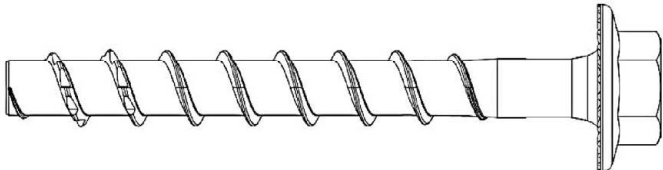
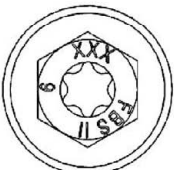
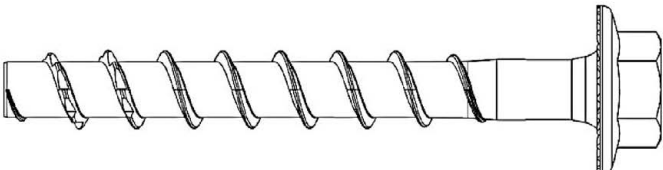

fischer concrete screw ULTRACUT FBS II

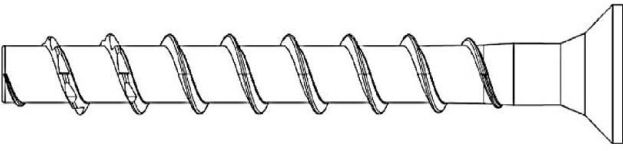
**Product description**  
Product in the installed condition

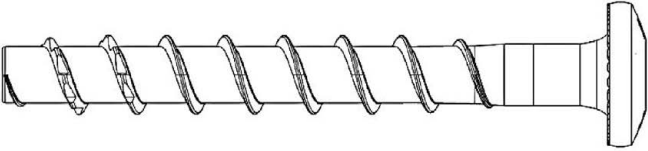
**Annex A 1**  
Appendix 3/ 18

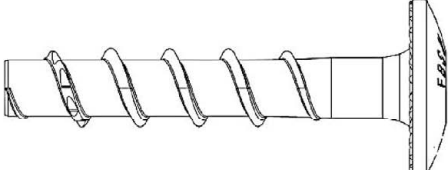
**Table A2.1:** Screw types FBS II 6

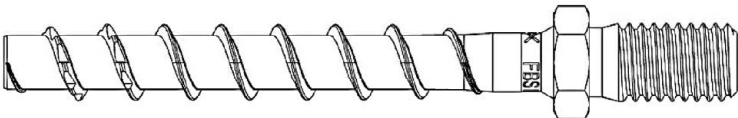
**FBS II 6**

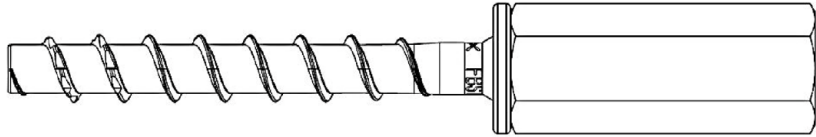
<p>Hexagon head with formed washer (US)</p>		
<p>Hexagon head with formed washer and TX-drive (US TX)</p>		
<p>Countersunk Head (SK)</p>		
<p>Pan head (P)</p>		
<p>Large Pan head (LP)</p>		
<p>Hexagon head and connection thread M8 or M10 (M)</p>		
<p>Internal thread combined (M6 I; M8/M10 I; M8/M12 I)</p>		

fischer concrete screw ULTRACUT FBS II

**Product description**  
Screw types FBS II 6

**Annex A 2**  
Appendix 4/ 18

**Table A3.1: Screw types FBS II 8 - 14**

**FBS II 8 - 14**

<p>Hexagon head with formed washer (US)</p>	
<p>Hexagon head with formed washer and TX-drive (US TX)</p>	
<p>Countersunk Head (SK)</p>	
<p>Hexagon head (S)</p>	
<p>Hexagon head with TX-drive (S TX)</p>	

fischer concrete screw ULTRACUT FBS II

**Product description**  
Screw types FBS II 8 to 14

**Annex A 3**  
Appendix 5/ 18

**Table A4.1: Geometry and material**

Screw types / size		All head shapes					
		6	8	10	12	14	
Thread outer diameter	$d_a$	[mm]	7,75	10,3	12,5	14,5	16,6
Core diameter	$d_k$		5,65	7,4	9,4	11,3	13,3
Shaft diameter	$d_s$		6,0	8,0	9,9	11,7	13,7
Material	[-]	Hardened carbon steel; $A_{5\%} \geq 8\%$					
Coating		galvanized					

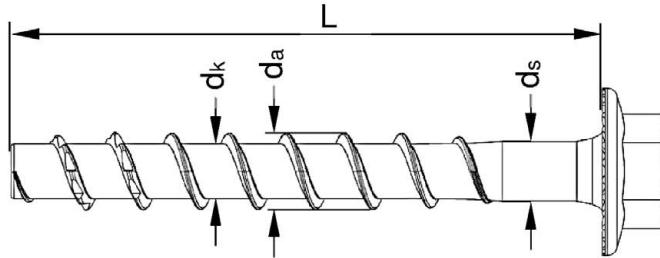

**Head marking US, US TX, S, S TX, SK, P, LP**

FBS II: Product identification

XXX: Screw length L

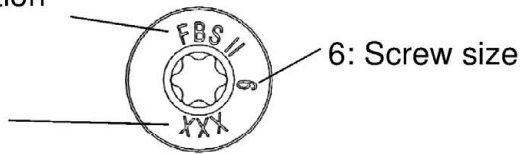

**Marking at M8, M10, M6 I, M8/M10 I, M8/M12 I**

Head marking:  
XX: Screw length L

Rotary marking:  
FBS II: Product identification  
6: Screw size

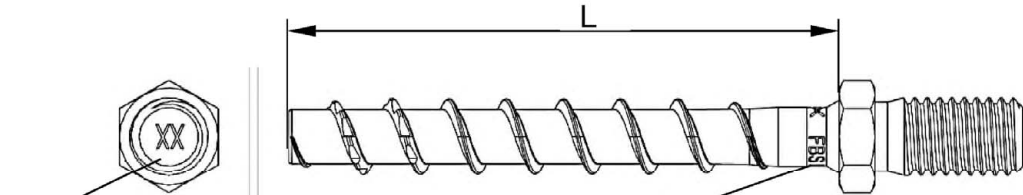

fischer concrete screw ULTRACUT FBS II

**Product description**  
Geometry and marking

**Annex A 4**  
Appendix 6/ 18



## Specification of intended use

**Table B1.1:** Anchorages subject to

Size	6		8		10			12			14		
Nominal embedment depth [mm]	40-55	50	65	55	65	85	60	75	100	65	85	115	
Static and quasi-static loads in cracked and uncracked concrete	✓												
Fire exposure													
Seismic performance category C1	✓		✓			✓			✓			✓	
Seismic performance category C2													

### Base materials:

- Compacted reinforced or unreinforced normal weight concrete without fibres (cracked and uncracked) according to EN 206:2013+A1:2016
- Strength classes C20/25 to C50/60 according to EN 206-1:2013+A1:2016

### Use conditions (Environmental conditions):

- Structures subjected to dry internal conditions

### Design:

- Anchorages are to be designed under the responsibility of an engineer experienced in anchorages and concrete work
- Verifiable calculation notes and drawings are to be prepared taking account of the loads to be anchored. The position of the screw is indicated on the design drawings (e.g. position of the screw relative to reinforcement or to supports, etc.).
- Design of fastenings according to EN 1992-4: 2018 and EOTA Technical Report TR 055

### Installation:

- Hammer drilling or hollow drilling:  
All sizes and embedment depths
- Alternative diamond drilling: All sizes and embedment depths from diameter 8
- Screw installation carried out by appropriately qualified personnel and under the supervision of the person responsible for technical matters on site
- In case of aborted hole: New hole must be drilled at a minimum distance of twice the depth of the aborted hole or closer, if the hole is filled with a high strength mortar and only if the hole is not in the direction of the oblique tensile or shear load.
- Adjustability according to Annex B4 for: All sizes and embedment depths
- Cleaning of drill hole is not necessary when using a hollow drill with functional suction or:
  - If drilling vertically upwards
  - If drilling vertical downwards and the drill hole depth has been increased. It is recommended to increase the drill depth with additional 3 do.
- After correct installation further turning of the screw head shall not be possible
- The head of the screw must be fully engaged on the fixture and show no signs of damage
- For seismic performance category C2 applications: The gap between screw shaft and fixture must be filled with mortar; mortar compressive strength  $\geq 50 \text{ N/mm}^2$  (e. g. FIS V, FIS HB, FIS SB or FIS EM Plus)

fischer concrete screw ULTRACUT FBS II

**Intended use**  
Specification

**Annex B 1**  
Appendix 7/ 18

**Table B2.1:** Installation parameters FBS II 6 - drilling bore hole and setting tools

FBS II 6			All head shapes
Nominal embedment depth	$h_{nom}$	[mm]	$40 \leq h_{nom} \leq 55$
Nominal drill hole diameter	$d_0$		6
Cutting diameter of drill bits	$d_{cut} \leq$		6,4
Clearance hole diameter	$d_f \leq$		8
Drill hole depth	$h_1 \geq$		$h_{nom} + 10^{1)}$
Drill hole depth (with adjustable setting)			$h_{nom} + 20$
Torque impact screw driver	$T_{imp,max}$	[Nm]	450
Maximum installation torque with metrical screws or hexagon nuts on head shapes M and I	$T_{max}$	[Nm]	10

<sup>1)</sup> Value can be reduced to  $h_{nom} + 5$  for installation vertically upwards

**Table B2.2:** Installation parameters FBS II 6 – drive and fixture

FBS II 6			US	US TX	SK	P	LP	M8	M10	M6 I	M8/M10 I	M8/M12 I	
Wrench size	SW	[mm]	10	-				10	13		15		
TX size	TX	[-]	-	30									
Head diameter	$d_h$	[mm]	17	13,5	14,4	17,5	-						
Thickness of fixture	$t_{fix} \leq$		$L - h_{nom}$										
Length of screw	$L_{min} =$		40										
	$L_{max} =$	325						55					

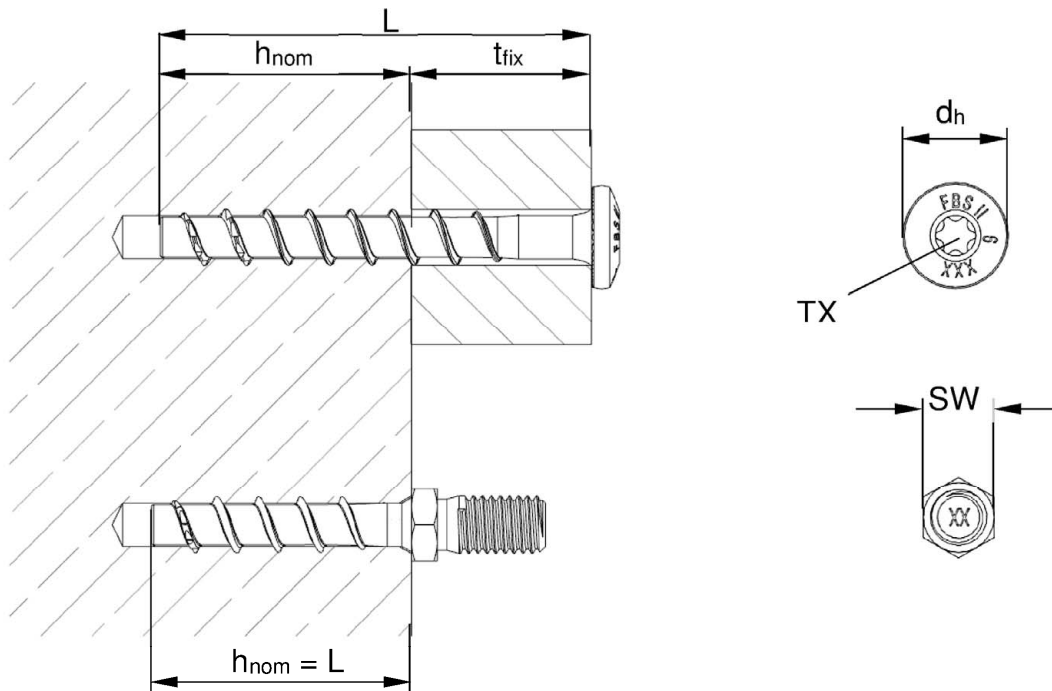

fischer concrete screw ULTRACUT FBS II

**Intended use**  
Installation parameters FBS II 6

**Annex B 2**  
Appendix 8/ 18

**Table B3.1:** Installation parameters FBS II 8 - 14

Size		FBS II										
		8		10			12			14		
Nominal embedment depth	$h_{nom}$	50	65	55	65	85	60	75	100	65	85	115
Nominal drill hole diameter	$d_0$	8		10			12			14		
Cutting diameter of drill bits	$d_{cut} \leq$	8,45		10,45			12,50			14,50		
Cutting diameter of diamond driller		[mm]	8,10		10,30			12,30			14,30	
Clearance hole diameter	$d_f$	10,6 – 12,0		12,8 – 14,0			14,8 – 16,0			16,9 – 18,0		
Wrench size (US,S)	SW	13		15			17			21		
Tx size	Tx	40		50			-					
Head diameter	$d_h$	18		21								
Countersunk diameter in fixture	$d_c$	20		23								
Drill hole depth	$h_1 \geq$	60	75	65	75	95	70	85	110	80	100	130
Drill hole depth (with adjustable setting)		[mm]	70	85	75	85	105	80	95	120	90	110
Thickness of fixture	$t_{fix} \leq$	L - $h_{nom}$										
Length of screw	$L_{min} =$	50	65	55	65	85	60	75	100	65	85	115
	$L_{max} =$	400	415	405	415	435	410	425	450	415	435	465
Torque impact screw driver	$T_{imp,max}$	600		650								

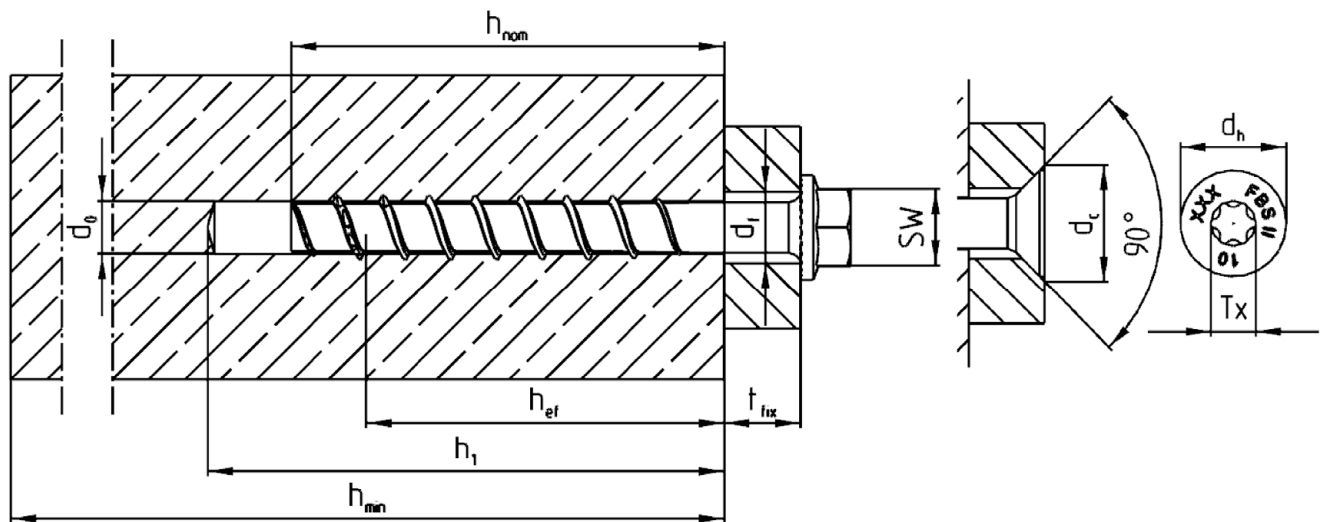

fischer concrete screw ULTRACUT FBS II

**Intended use**  
Installation parameters FBS II 8 - 14

**Annex B 3**  
Appendix 9/ 18

## Adjustment

1)

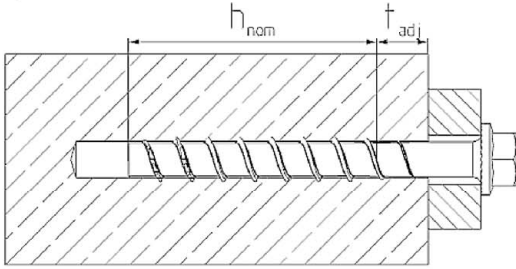

2)

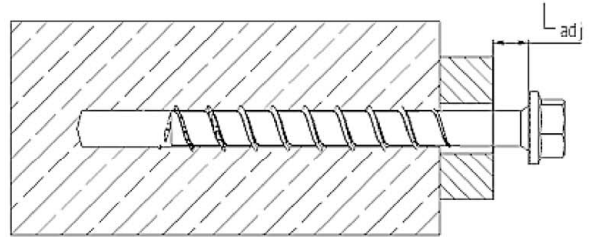

3)

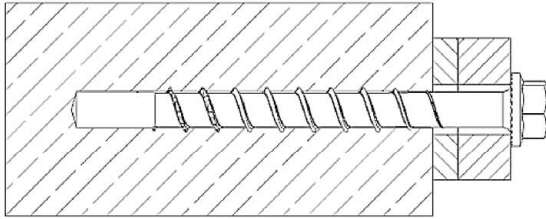

4)

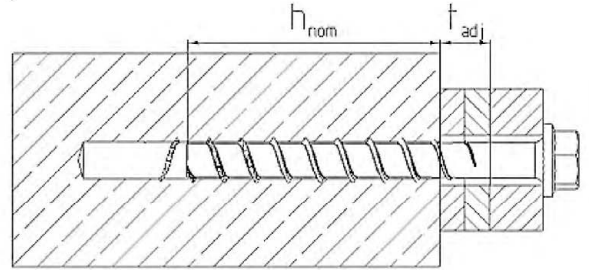

It is permissible to untighten the screw up to two times for adjustment purposes.

Therefore the screw may be untightened to a maximum of  $L_{adj} = 20$  mm to the surface of the initial fixture.

The total permissible thickness of shims added during the adjustment process is  $t_{adj} = 10$  mm

**Table B4.1:** Minimum thickness of concrete members, minimum spacing and edge distance

Size		FBS II												
		6		8		10			12		14			
Nominal embedment depth	$h_{nom}$	[mm]	40 to 55	50	65	55	65	85	60	75	100	65	85	115
Minimum thickness of concrete member	$h_{min}$		max.(80; $h_1^{1)} + 30$ )	100	120	100	120	140	110	130	150	120	140	180
Minimum spacing	$s_{min}$		35	35	40			50		60				
Minimum edge distance	$c_{min}$		35	35	40			50		60				

<sup>1)</sup> Drill hole depth according to table B2.1

fischer concrete screw ULTRACUT FBS II

**Intended use**

Adjustment

Minimum thickness of members, minimum spacing and edge distance

**Annex B 4**

Appendix 10/ 18

# Installation instruction

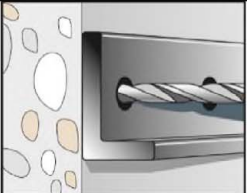
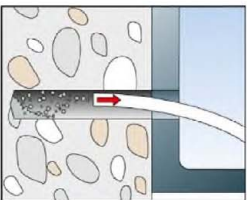
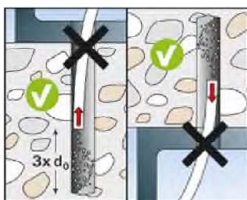
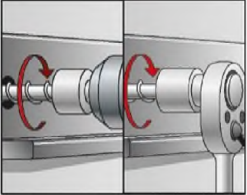
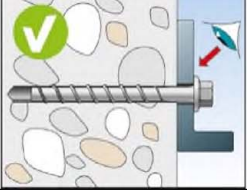
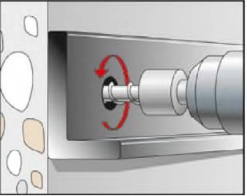
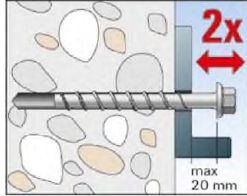
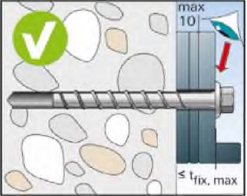
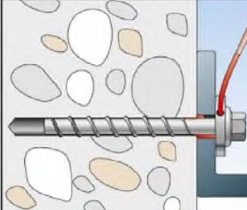
		<p>Drill the hole using hammer drill, hollow drill or diamond core drill.</p> <p>Drill hole diameter <math>d_0</math> and drill hole depth <math>h_1</math> according to table B2.1 and B3.1</p>
<p>a)</p> 	<p>b)</p> 	<p>Option a): Clean the drill hole</p> <p>Option b): Cleaning of drill hole is not necessary when using a hollow drill or a diamond drill or:</p> <ul style="list-style-type: none"> <li>- If drilling vertically upwards or</li> <li>- If drilling vertically downwards and the drill hole depth has been increased. It is recommended to increase the drill hole depth additional 3 times <math>d_0</math>.</li> </ul>
		<p>Installation with any torque impact screw driver up to the maximum mentioned torque moment (<math>T_{imp,max}</math> according to table B2.1 and B3.1). Alternatively, all other tools without an indicated torque moment are allowed (e.g. ratchet spanner). The indicated torque moments for impact screw driver are therefore not decisive.</p>
		<p>After installation a further turning of the screw must not be possible. The head of the screw must be in contact with the fixture and is not damaged</p>
<p>1.</p>  <p>2.</p>  <p>3.</p> 		<p>Optional: It is permissible to adjust the screw twice. Therefore the screw may be untightened to a maximum of <math>L_{adj} = 20</math> mm off the surface of the initial fixture. The total permissible thickness of shims added during the adjustment process is <math>t_{adj} = 10</math> mm.</p>
		<p>For seismic performance category C2 applications: The gap between screw shaft and fixture must be filled with mortar; mortar compressive strength <math>\geq 50</math> N/mm<sup>2</sup> (e. g. FIS V, FIS HB, FIS SB or FIS EM Plus). As an aid for filling the gap, the filling disc FFD is recommended.</p>

fischer concrete screw ULTRACUT FBS II

**Intended use**  
Installation instruction

**Annex B 5**  
Appendix 11/ 18

<b>Table C1.1: Characteristic values for static and quasi-static action with FBS II 6</b>								
<b>FBS II 6</b>								
Nominal embedment depth	$h_{nom}$	[mm]	40	45	50	55		
<b>Steel failure for tension load and shear load</b>								
Characteristic resistance	$N_{Rk,s}$	[kN]	21					
Partial factor	$\gamma_{Ms}$	[-]	1,4					
Characteristic resistance	$V^0_{Rk,s}$	[kN]	9,0			13,3		
Partial factor	$\gamma_{Ms}$	[-]	1,5					
Factor for ductility	$k_7$		1,0					
Characteristic bending resistance	$M^0_{Rk,s}$	[Nm]	17,1					
<b>Pullout failure</b>								
Characteristic resistance in concrete C20/25	uncracked	$N_{Rk,p}$	[kN]	8,0	10,0	12,0	13,5	
	cracked	$N_{Rk,p}$		2,5	3,5	4,0	5,0	
Increasing factors concrete	C25/30	$\psi_c$	[-]	1,12				
	C30/37			1,22				
	C35/45			1,32				
	C40/50			1,41				
	C45/55			1,50				
	C50/60			1,58				
Installation factor	$\gamma_{inst}$	[-]	1,0					
<b>Concrete cone failure and splitting failure; concrete pryout failure</b>								
Effective embedment depth	$h_{ef}$	[mm]	32	36	40	44		
Factor for uncracked concrete	$k_{ucr,N}$	[-]	11,0					
Factor for cracked concrete	$k_{cr,N}$		7,7					
Characteristic edge distance	$c_{cr,N}$	[mm]	1,5 $h_{ef}$					
Characteristic spacing	$s_{cr,N}$		3 $h_{ef}$					
Charakt. resistance for splitting	$N^0_{Rk,sp}$	[kN]	$\min(N^0_{Rk,c}{}^1; N_{Rk,p})$					
Charact. edge distance for splitting	$c_{cr,sp}$	[mm]	1,5 $h_{ef}$					
Charakt. spacing for splitting	$s_{cr,sp}$		3 $h_{ef}$					
Factor for pryout failure	$k_8$	[-]	2,0					
Installation factor	$\gamma_{inst}$		1,0					
<b>Concrete edge failure</b>								
Effective length in concrete	$l_f$	[mm]	40	45	50	55		
Nominal diameter of screw	$d_{nom}$		6					
<b>Adjustment</b>								
Maximum thickness of shims	$t_{adj}$	[mm]	10					
Max. number of adjustments	$n_a$	[-]	2					
<sup>1)</sup> $N^0_{Rk,c}$ according EN 1992-4:2018								
fischer concrete screw ULTRACUT FBS II						<b>Annex C 1</b> Appendix 12/ 18		
<b>Performances</b> Characteristic values for static and quasi-static action with FBS II 6								

<b>Table C2.1:</b> Characteristic values for static and quasi-static action with FBS II 8 - 14													
Size			FBS II										
			8		10			12			14		
Nominal embedment depth	$h_{nom}$	[mm]	50	65	55	65	85	60	75	100	65	85	115
<b>Steel failure for tension load and shear load</b>													
Characteristic resistance	$N_{Rk,s}$	[kN]	35		55			76			103		
Partial factor	$\gamma_{Ms}$	[-]	1,4										
Characteristic resistance	$V^0_{Rk,s}$	[kN]	13,1	19,0	29,4		34,9	31,9		42,7	46,5		61,7
Partial factor	$\gamma_{Ms}$	[-]	1,5										
Factor for ductility	$k_7$		1,0										
Characteristic bending resistance	$M^0_{Rk,s}$	[Nm]	51		95			165			269		
<b>Pullout failure</b>													
Characteristic resistance in concrete C20/25	uncracked	$N_{Rk,p}$	[kN]		$\geq N^0_{Rk,c}{}^1)$								
	cracked	$N_{Rk,p}$	[kN]	6	12	9	12	$\geq N^0_{Rk,c}{}^1)$					
Increasing factors concrete	C25/30	$\psi_c$	[-]	1,12									
	C30/37			1,22									
	C35/45			1,32									
	C40/50			1,41									
	C45/55			1,50									
	C50/60			1,58									
Installation factor	$\gamma_{inst}$	[-]	1,0										
<b>Concrete cone failure and splitting failure; concrete pryout failure</b>													
Effective embedment depth	$h_{ef}$	[mm]	40	52	43	51	68	47	60	81	50	67	93
Factor for uncracked concrete	$k_{ucr,N}$	[mm]	11,0										
Factor for cracked concrete	$k_{cr,N}$	[mm]	7,7										
Characteristic edge distance	$c_{cr,N}$	[mm]	$1,5 h_{ef}$										
Characteristic spacing	$s_{cr,N}$	[mm]	$3 h_{ef}$										
Charakt. resistance for splitting	$N^0_{Rk,sp}$	[kN]	$\min(N^0_{Rk,c}{}^1); N_{Rk,p}$										
Charact. edge distance for splitting	$c_{cr,sp}$	[mm]	$1,5 h_{ef}$										
Charakt. spacing for splitting	$s_{cr,sp}$	[mm]	$3 h_{ef}$										
Factor for pryout failure	$k_8$	[-]	1,0	2,0	1,0	2,0							
Installation factor	$\gamma_{inst}$	[-]	1,0										
<b>Concrete edge failure</b>													
Effective length in concrete	$l_f$	[mm]	50	65	55	65	85	60	75	100	65	85	115
Nominal diameter of screw	$d_{nom}$	[mm]	8		10			12			14		
<b>Adjustment</b>													
Maximum thickness of shims	$t_{adj}$	[mm]	10										
Max. number of adjustments	$n_a$	[-]	2										
1) $N^0_{Rk,c}$ according EN 1992-4:2018													
fischer concrete screw ULTRACUT FBS II											<b>Annex C 2</b> Appendix 13/ 18		
<b>Performances</b> Characteristic values for static and quasi-static action with FBS II 8 - 14													

<b>Table C3.1: Characteristic values for seismic performance category C1 with FBS II 6</b>						
<b>FBS II 6</b>						
Nominal embedment depth	$h_{nom}$	[mm]	40	45	50	55
<b>Steel failure for tension load and shear load</b>						
Characteristic resistance	$\frac{N_{Rk,s,C1}}{V_{Rk,s,C1}}$	[kN]	21			
			6,3			9,3
Without filling of the annular gap <sup>1)</sup>	$\alpha_{gap}$	[-]	0,5			
With filling of the annular gap <sup>1)</sup>			1,0			
<b>Pullout failure</b>						
Characteristic resistance in cracked concrete	$N_{Rk,p,C1}$	[kN]	2,5	3,5	4,0	5,0
<b>Concrete cone failure</b>						
Effective embedment depth	$h_{ef}$	[mm]	32	36	40	44
Characteristic edge distance	$c_{cr,N}$		1,5 $h_{ef}$			
Characteristic spacing	$s_{cr,N}$		3 $h_{ef}$			
Installation factor	$\gamma_{inst}$	[-]	1,0			
<b>Concrete pryout failure</b>						
Factor for pryout failure	$k_8$	[-]	2,0			
<b>Concrete edge failure</b>						
Effective length in concrete	$l_f$	[mm]	40	45	50	55
Nominal diameter of screw	$d_{nom}$		6			

**Table C3.2: Characteristic values for seismic performance category C1 with FBS II 8 – 14**

Size		<b>FBS II</b>				
		<b>8</b>	<b>10</b>	<b>12</b>	<b>14</b>	
Nominal embedment depth	$h_{nom}$	[mm]	65	85	100	115
<b>Steel failure for tension load and shear load</b>						
Characteristic resistance	$\frac{N_{Rk,s,C1}}{V_{Rk,s,C1}}$	[kN]	35	55	76	103
			11,4	22,3	26,9	38,3
Without filling of the annular gap <sup>1)</sup>	$\alpha_{gap}$	[-]	0,5			
With filling of the annular gap <sup>1)</sup>			1,0			
<b>Pullout failure</b>						
Characteristic resistance in cracked concrete	$N_{Rk,p,C1}$	[kN]	12	$\geq N_{Rk,c}^{0(2)}$		
<b>Concrete cone failure</b>						
Effective embedment depth	$h_{ef}$	[mm]	52	68	81	93
Characteristic edge distance	$c_{cr,N}$		1,5 $h_{ef}$			
Characteristic spacing	$s_{cr,N}$		3 $h_{ef}$			
Installation factor	$\gamma_{inst}$	[-]	1,0			
<b>Concrete pryout failure</b>						
Factor for pryout failure	$k_8$	[-]	2,0			
<b>Concrete edge failure</b>						
Effective length in concrete	$l_f$	[mm]	65	85	100	115
Nominal diameter of screw	$d_{nom}$		8	10	12	14

<sup>1)</sup> Filling of the annular gap according annex B 5.

<sup>2)</sup>  $N_{Rk,c}^0$  according EN 1992-4:2018

fischer concrete screw ULTRACUT FBS II	<b>Annex C 3</b> Appendix 14/ 18
<b>Performances</b> Characteristic values for seismic performance category C1	



**Table C4.1:** Characteristic values for seismic performance category C2

Size			FBS II			
			8	10	12	14
Nominal embedment depth	$h_{nom}$	[mm]	65	85	100	115
<b>Steel failure for tension load and shear load</b>						
Characteristic resistance	$\frac{N_{Rk,s,C2}}{V_{Rk,s,C2}}$	[kN]	35,0	55	76,0	103
			13,3	20,4	29,9	35,2
With filling of the annular gap <sup>1)</sup>	$\alpha_{gap}$	[-]	1,0			
<b>Pullout failure</b>						
Characteristic resistance in cracked concrete	$N_{Rk,p,C2}$	[kN]	2,1	6,0	8,9	17,1
<b>Concrete cone failure</b>						
Effective embedment depth	$h_{ef}$	[mm]	52	68	81	93
Characteristic edge distance	$c_{cr,N}$		1,5 $h_{ef}$			
Characteristic spacing	$s_{cr,N}$		3 $h_{ef}$			
Installation factor	$\gamma_{inst}$	[-]	1,0			
<b>Concrete pryout failure</b>						
Factor for pryout failure	$k_8$	[-]	2,0			
<b>Concrete edge failure</b>						
Effective length in concrete	$l_f$	[mm]	65	85	100	115
Nominal diameter of screw	$d_{nom}$		8	10	12	14

<sup>1)</sup> Filling of the annular gap according annex B 5. Application without filling of the annular gap not allowed.

fischer concrete screw ULTRACUT FBS II

**Performances**

Characteristic values for seismic performance category C2 with FBS II 8 - 14

**Annex C 4**

Appendix 15/ 18

<b>Table C5.1:</b> Characteristic values for resistance to fire with FBS II 6 <sup>1)</sup>						
<b>FBS II 6</b>						
Nominal embedment depth	$h_{nom}$	[mm]	40	45	50	55
<b>Steel failure for tension load and shear load</b>						
Characteristic resistance for all head shapes	$N_{Rk,s,fi}$	R30	[kN]	1,00		
		R60		0,60		
		R90		0,50		
		R120		0,40		
	$V_{Rk,s,fi}$	R30		1,00		
		R60		0,60		
		R90		0,50		
		R120		0,40		
Characteristic bending resistance for all head shapes	$M^0_{Rk,s,fi}$	R30	[Nm]	0,80		
		R60		0,50		
		R90		0,40		
		R120		0,35		
<b>Pullout failure</b>						
Characteristic resistance	$N_{Rk,p,fi}$	R30	[kN]	0,6	0,9	1,0
		R60				
		R90				
		R120				
<b>Edge distance</b>						
R30 to R120	$c_{cr,fi}$	[mm]	2 $h_{ef}$			
In case of fire attack from more than one side, the minimum edge distance shall be $\geq 300$ mm						
<b>Spacing</b>						
R30 to R120	$s_{cr,fi}$	[mm]	2 $c_{cr,fi}$			
<sup>1)</sup> The embedment depth has to be increased for wet concrete by at least 30 mm compared to the given value.						
fischer concrete screw ULTRACUT FBS II						<b>Annex C 5</b> Appendix 16/ 18
<b>Performances</b> Characteristic values for resistance to fire with FBS II 6						

**Table C6.1:** Characteristic values for resistance to fire with FBS II 8 – 14 <sup>1)</sup>

Size			FBS II																						
			8		10			12			14														
Nominal embedment depth	$h_{nom}$	[mm]	50	65	55	65	85	60	75	100	65	85	115												
<b>Steel failure for tension load and shear load</b>																									
Characteristic resistance for the head shapes	US, S	$N_{Rk,s,fi}$	R30	[kN]	2,33		3,45			4,62			6,46												
			R60		1,82		2,73			3,66			5,11												
			R90		1,30		2,00			2,69			3,75												
			R120		1,04		1,64			2,20			3,08												
		$V_{Rk,s,fi}$	R30	2,33		3,45			4,62			6,46													
			R60	1,82		2,73			3,66			5,11													
			R90	1,30		2,00			2,69			3,75													
			R120	1,04		1,64			2,20			3,08													
	SK, US TX, S TX	$N_{Rk,s,fi}$	R30	2,12		2,96			No performance assessed																
			R60	1,67		2,26																			
			R90	1,21		1,56																			
			R120	0,99		1,21																			
		$V_{Rk,s,fi}$	R30	2,12		2,96																			
			R60	1,67		2,26																			
			R90	1,21		1,56																			
			R120	0,99		1,21																			
	All head shapes	$M^0_{Rk,s,fi}$	[Nm]	R30	2,62		4,92			7,83		12,89													
				R60	2,05		3,89			6,20		10,19													
				R90	1,46		2,85			4,56		7,48													
				R120	1,17		2,34			3,73		6,14													
<b>Pullout failure</b>																									
Characteristic resistance	$N_{Rk,p,fi}$	[kN]	R30	1,5		3,0		2,3		3,0		5,0		2,9		4,2		6,6		3,2		4,9		8,1	
			R60	1,2		2,4		1,8		2,4		4,0		2,3		3,3		5,2		2,5		3,9		6,5	
			R90																						
			R120																						
<b>Edge distance</b>																									
R30 to R120	$C_{cr,fi}$	[mm]	$2 h_{ef}$																						
In case of fire attack from more than one side, the minimum edge distance shall be $\geq 300$ mm																									
<b>Spacing</b>																									
R30 to R120	$S_{cr,fi}$	[mm]	$2 C_{cr,fi}$																						

<sup>1)</sup> The embedment depth has to be increased for wet concrete by at least 30 mm compared to the given value.

fischer concrete screw ULTRACUT FBS II

**Performances**

Characteristic values for resistance to fire with FBS II 8 - 14

**Annex C 6**

Appendix 17/ 18

**Table C7.1:** Displacements due to tension loads (static)

Size			FBS II												
			6 <sup>1)</sup>		8		10			12			14		
Nominal embedment depth	$h_{nom}$	[mm]	40	55	50	65	55	65	85	60	75	100	65	85	115
Tension load in cracked concrete	N	[kN]	2,0	3,5	2,9	5,7	4,3	5,7	9,6	5,5	8,0	12,5	6,1	9,4	15,3
Displacement	$\frac{\delta_{N0}}{\delta_{N\infty}}$	[mm]	1,1	1,4	0,5	0,9	0,7	0,7	0,8	0,7	0,9	0,8	0,8	1,0	0,8
			2,5	2,5	1,3	1,0	0,7	0,7	0,8	1,3	0,9	0,8	1,1	1,0	1,1
Tension load in uncracked concrete	N	[kN]	4,0	7,0	7,9	12,0	6,8	8,8	13,5	7,7	11,0	17,4	8,5	13,2	21,6
Displacement	$\frac{\delta_{N0}}{\delta_{N\infty}}$	[mm]	1,0	1,8	0,9	1,4	0,9	0,9	1,4	0,9	1,1	1,4	1,0	1,3	1,1
			1,7	2,6	1,4	1,4	1,4	1,4	1,4	1,4	1,4	1,4	1,1	1,3	1,1

<sup>1)</sup> Intermediate values by linear interpolation

**Table C7.2:** Displacements due to shear loads (static)

Size			FBS II												
			6 <sup>1)</sup>		8		10			12			14		
Nominal embedment depth	$h_{nom}$	[mm]	40	55	50	65	55	65	85	60	75	100	65	85	115
Shear load in cracked and uncracked concrete	V	[kN]	4,5	6,7	6,2	9,0	14,0	14,0	16,6	15,9	15,9	21,2	23,0	23,0	30,5
Displacement	$\frac{\delta_{V0}}{\delta_{V\infty}}$	[mm]	2,0	2,9	1,4	1,4	3,2	3,2	3,2	2,5	2,5	3,4	2,8	2,8	5,4
			2,9	4,4	2,0	2,1	4,9	4,9	4,9	3,8	3,8	5,1	4,2	4,2	8,1

<sup>1)</sup> Intermediate values by linear interpolation

**Table C7.3:** Displacements due to tension loads (seismic performance category C2)

Size			FBS II			
			8	10	12	14
Nominal embedment depth	$h_{nom}$		65	85	100	115
Displacement DLS	$\delta_{N,C2}$ (DLS)	[mm]	0,5	0,8	0,9	1,3
Displacement ULS	$\delta_{N,C2}$ (ULS)		1,7	2,8	2,7	5,0

**Table C7.4:** Displacements due to shear loads (seismic performance category C2)

Size			FBS II			
			8	10	12	14
Nominal embedment depth	$h_{nom}$		65	85	100	115
Displacement DLS	$\delta_{V,C2}$ (DLS)	[mm]	1,6	2,7	3,1	4,1
Displacement ULS	$\delta_{V,C2}$ (ULS)		3,9	7,1	5,3	8,7

fischer concrete screw ULTRACUT FBS II

**Performances**  
Displacements due to tension and shear loads

**Annex C 7**  
Appendix 18/ 18